

PRODUCT INFORMATION AND SPECIFICATION SHEET

SOLARIS KEYPADS – 144 MM

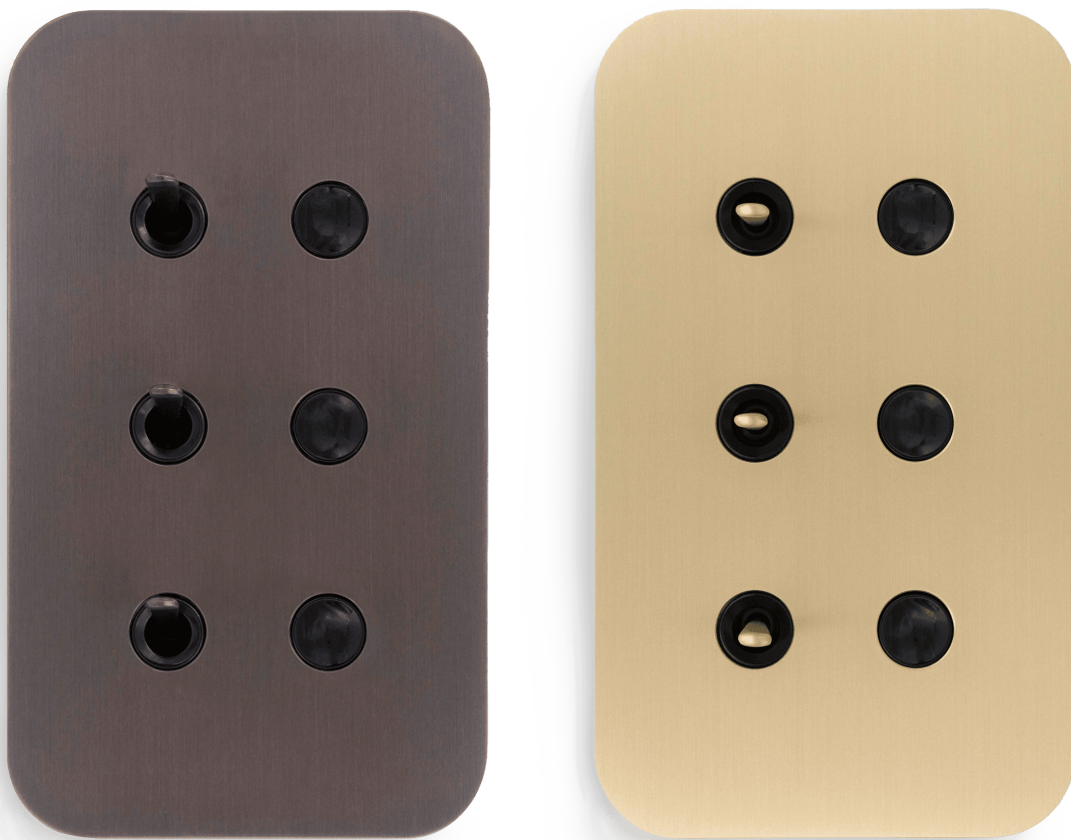

SOLARIS KEYPADS – 144 MM || PRODUCT INFORMATION

DESCRIPTION

Solaris collection keypads for use with lighting control / home automation systems. Compatible systems include Crestron, Control4, Lutron HomeWorks, Savant and Vantage. Designed in partnership with Sir Marc Newson.

Made in France.

PERSONALIZED PLATE DETAILS

FINISHES

Cover plates are made-to-order in any of the following finishes: Polished Chrome, Sandblasted Gunmetal, Light Bronze, Light Bronze Matte, Medium Bronze, Dark Bronze, Satin Brass, Golden Brushed Brass, Polished Brass, Dark Brushed Silver, Dark Brushed Copper, Aged Burnished Copper, Satin Copper, Antique Copper, Dark Polished Bronze, Belgian Gunmetal, and Antique Brass NA. Examples of all our finishes are available in the [Meljac Finish Catalog](#).

MECHANISM OPTIONS

Low-voltage momentary dry contact toggles and push buttons for use in class-2 wiring circuits only.

- BP - Momentary Push Button ("normally-open"). One contact closure.
- INV - Three-position toggle switch, returns to center position. Two contact closures ("UP" and "DOWN").
- INV M - Three position latching toggle switch. Switch can rest up at "UP" contact, center "OFF", or "DOWN" contact. Two maintained contact closures.

Mechanisms can be combined and configured according to project control needs.

Note: Additional low-voltage control options available. Contact MNA for more information.

MECHANISM FINISH

- Glossy Black Brass - default
- Matched to plate finish - see [Finish Catalog](#) for available finishes.

SCREW TYPE

- Hidden

EDGE TYPE

- Straight

LED FEEDBACK

- 3 mm or 8 mm LED Indicators
- Backlit Engravings
- 12V or 24V remote power required.

ENGRAVINGS

Default: 3 mm / Arial Font / Mechanical Style
9 characters per line + 2 lines per mechanism
See [MNA Engraving Options](#) for more details.

BACK BOX

MEL14280

See our [Plate Size & Back Box Guide](#) for more information.

CERTIFICATION

Conforms to UL 916 and CSA-C22.2 No. 205-12 IP20



CARE / CLEANING INSTRUCTIONS

To protect the integrity of the finish, no chemicals or cleaning solutions should ever be used. Dry dust rags or microfiber cloths only.

SOLARIS KEYPADS – 144 MM || DIMENSIONAL DRAWINGS

DIMENSIONAL DRAWINGS

Measurements: mm (inches)

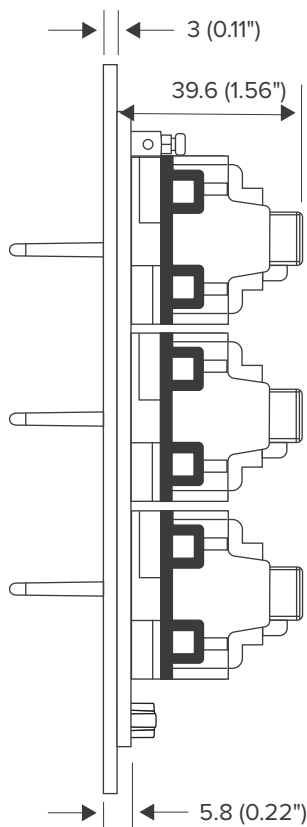
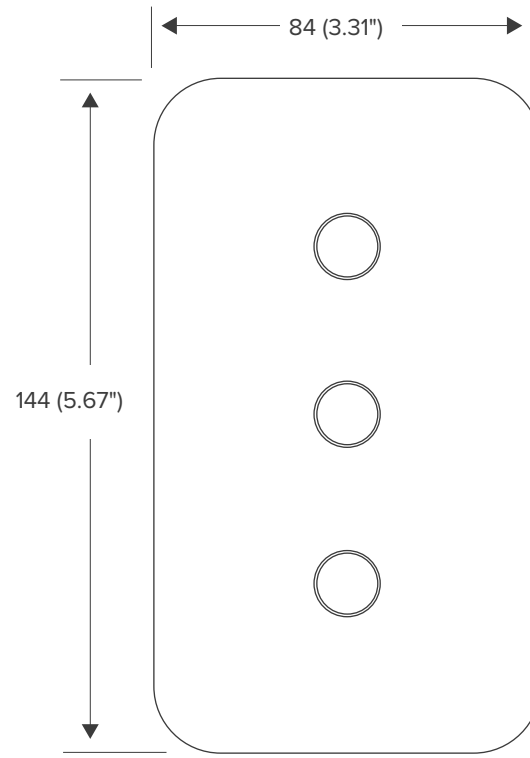
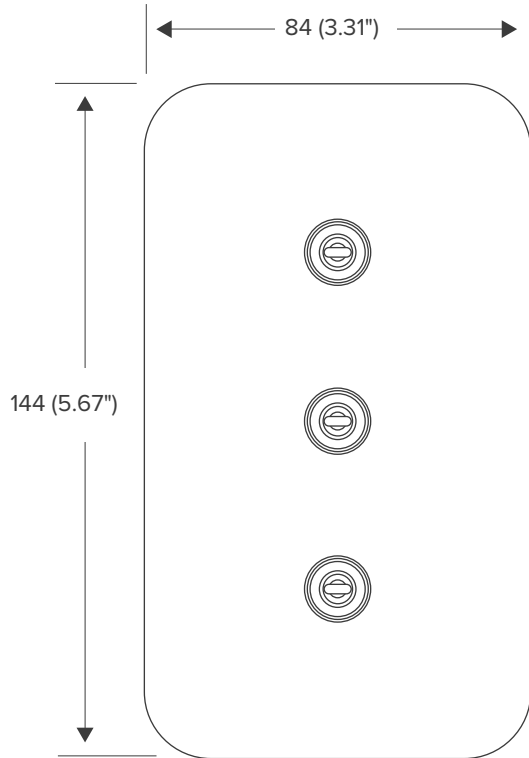

Supplied 6-32
Flat Torx Head
Machine Screw

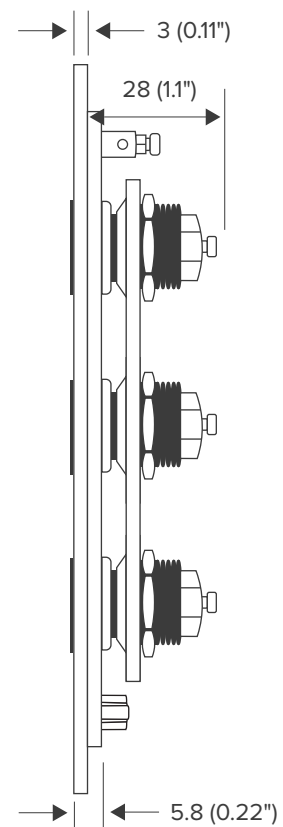

SOLARIS KEYPADS – 144 MM || MOUNTING DRAWINGS

BACK BOX

MEL14280

See our [Plate Size & Back Box Reference Guide](#) for more information.

Hidden Screw Plate Construction

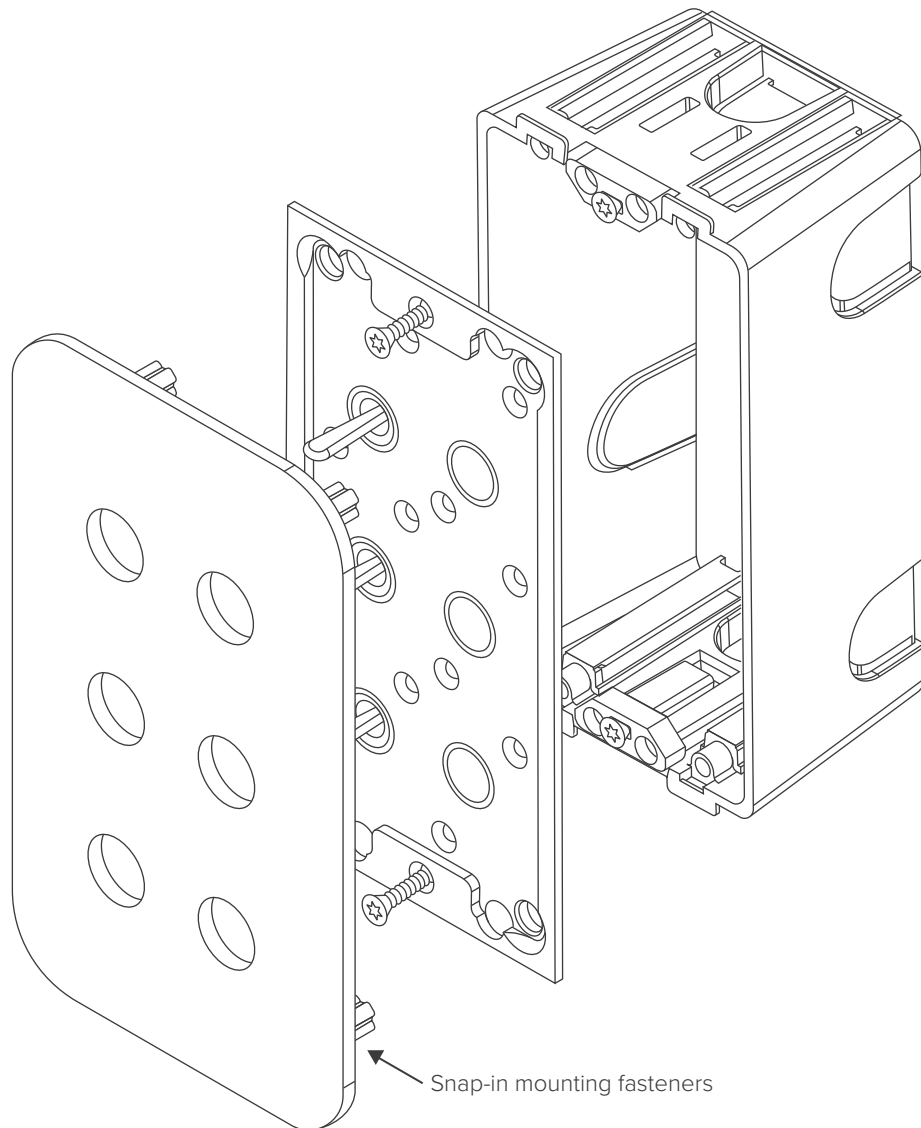

SOLARIS KEYPADS – 144 MM || SPECIFICATION SHEET

PROJECT NAME: _____

SPECIFIER: _____

PLATE FINISH: _____

MECHANISM SURROUND FINISH Select one

- Glossy Deep Black - default
- Polished Chrome
- Brushed Brass

TOGGLE / PUSH BUTTON CONFIGURATIONS Select one

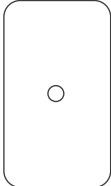
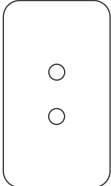
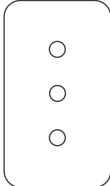
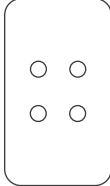
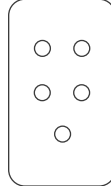
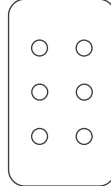
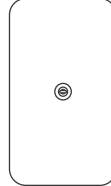
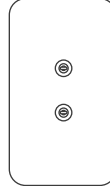
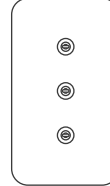
| | | | | | | | | |
|--|--|--|--|--|--|--|--|--|
|  |  |  |  |  |  |  |  |  |
| <input type="checkbox"/> 1 BP | <input type="checkbox"/> 2 BP | <input type="checkbox"/> 3 BP | <input type="checkbox"/> 4 BP | <input type="checkbox"/> 5 BP | <input type="checkbox"/> 6 BP | <input type="checkbox"/> 1 INV | <input type="checkbox"/> 2 INV | <input type="checkbox"/> 3 INV |

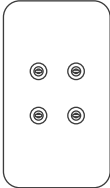
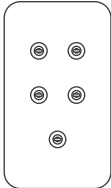
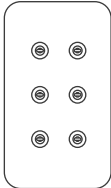
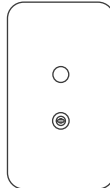
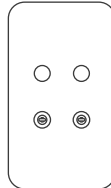
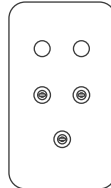
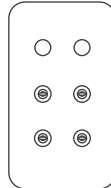
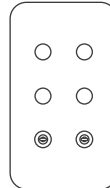
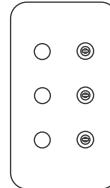
| | | | | | | | | |
|---|---|---|---|---|---|---|---|---|
|  |  |  |  |  |  |  |  |  |
| <input type="checkbox"/> 4 INV | <input type="checkbox"/> 5 INV | <input type="checkbox"/> 6 INV | <input type="checkbox"/> 1 BP + 1 INV | <input type="checkbox"/> 2 BP + 2 INV | <input type="checkbox"/> 2 BP + 3 INV | <input type="checkbox"/> 2 BP + 4 INV | <input type="checkbox"/> 4 BP + 2 INV | <input type="checkbox"/> 3 BP + 3 INV |

ENGRAVINGS

| | | | |
|--|--|---|---|
| PLACEMENT Select one | STYLE Select one | FONT Select one | SIZE Select one |
| <input type="checkbox"/> Above Mechanism | <input type="checkbox"/> Mechanical | <input type="checkbox"/> Arial | <input type="checkbox"/> 3 mm |
| <input type="checkbox"/> Below Mechanism | <input type="checkbox"/> Resin-filled: RAL Color _____ | <input type="checkbox"/> Helvetica | <input type="checkbox"/> 3.5 mm |
| <input type="checkbox"/> No Engravings | <input type="checkbox"/> Screen-Printed | <input type="checkbox"/> Custom _____ | <input type="checkbox"/> 4 mm |
| | <input type="checkbox"/> Back-lit | | <input type="checkbox"/> Custom _____ |