

## PRODUCT INFORMATION AND SPECIFICATION SHEET

---

### CLASSIQUE KEYPADS – 117 MM



## CLASSIQUE KEYPADS – 117 MM || PRODUCT INFORMATION

### DESCRIPTION

Classique collection push buttons and toggles for use with lighting control / home automation systems. Compatible systems include Crestron, Control4, Lutron HomeWorks, Savant and Vantage.

Made in France.

### PERSONALIZED PLATE DETAILS

#### FINISHES

Cover plates are made-to-order in any of the finishes included in the [Meljac Finish Catalog](#). Meljac offers over 30 finishes in materials including chrome, copper, gunmetal, nickel, brass and bronze.

Powdercoating is available in any specification from the [RAL Color Chart](#).

Custom-matched finish options are also available, dependent upon project size and finish details.

#### MECHANISM OPTIONS

Low-voltage momentary dry contact toggles and push buttons for use in class-2 wiring circuits only.

- BP - Momentary Push Button ("normally-open"). One contact closure.
- INV - Three-position toggle switch, returns to center position. Two contact closures ("UP" and "DOWN").
- INV M - Three position latching toggle switch. Switch can rest up at "UP" contact, center "OFF", or "DOWN" contact. Two maintained contact closures.

Mechanisms can be combined and configured according to project control needs.

Note: Additional low-voltage control options available. Contact MNA for more information.

#### MECHANISM FINISH

- Chrome - default for copper, chrome, nickel and gunmetal plates
- Brass - default for brass and bronze plates
- Black Chrome - premium option
- Matched to plate finish - premium option; see [Finish Catalog](#) for available finishes.

#### SCREW TYPE

- Visible - Torx Head
- Visible - Slot Head
- Hidden

#### EDGE TYPE

- Beveled
- Straight

#### LED FEEDBACK

- 3 mm or 8 mm LED Indicators
- Backlit Engravings
- 12V or 24V remote power required.

#### ENGRAVINGS

Default: 3 mm / Arial Font / Mechanical Style  
9 characters per line + 2 lines per mechanism  
See [MNA Engraving Options](#) for more details.

### BACK BOX

Visible screw plates 117 mm plates are compatible with any single-gang box or ring.

Hidden screw plates must use either the Meljac MELUS11782 back box or a compatible 3rd party option.

See [Plate Size and Back Box Guide](#) for options.

Note: back boxes must be installed perfectly level to prevent plate installation from being crooked.

### CERTIFICATION

Conforms to UL 916 and CSA-C22.2 No. 205-12 IP20



### CARE / CLEANING INSTRUCTIONS

To protect the integrity of the finish, no chemicals or cleaning solutions should ever be used. Dry dust rags or microfiber cloths only.

# CLASSIQUE KEYPADS – 117 MM || DIMENSIONAL DRAWINGS

## DIMENSIONAL DRAWINGS

Measurements: mm (inches)

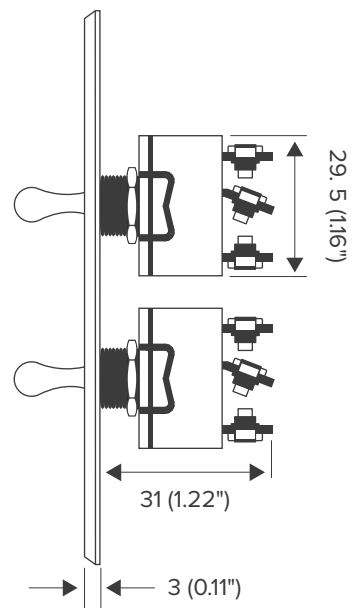
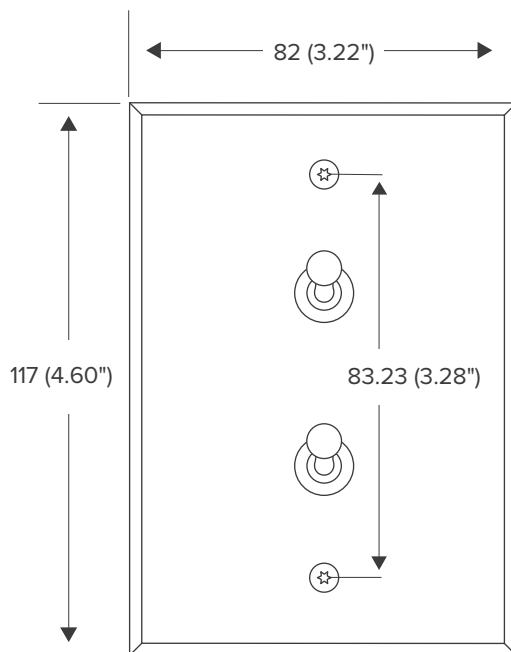
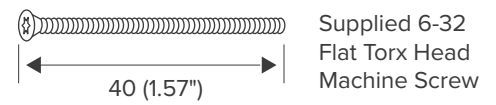
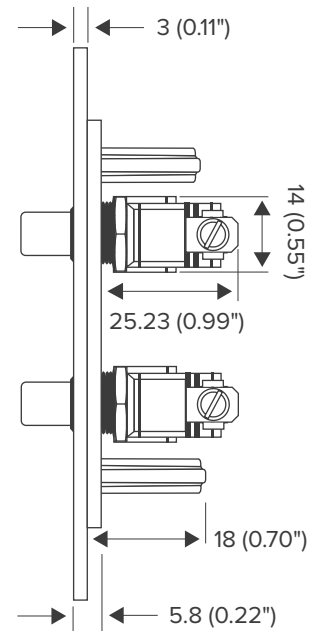
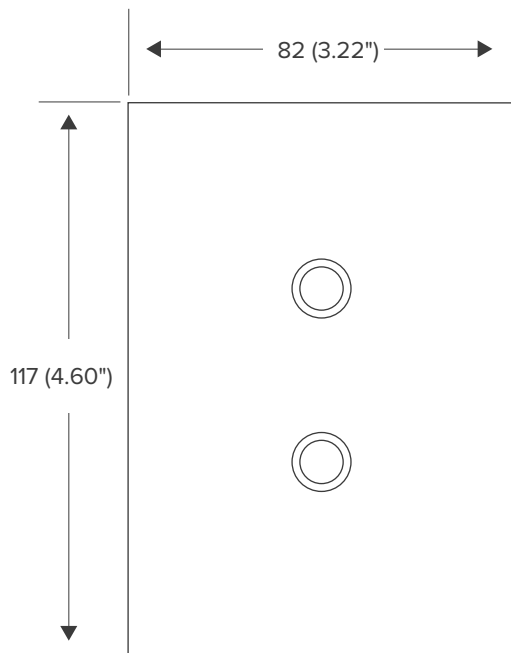

## CLASSIQUE KEYPADS – 117 MM || MOUNTING DRAWINGS

### BACK BOX

MELUS11782

See our [Plate Size & Back Box Reference Guide](#) for more information.

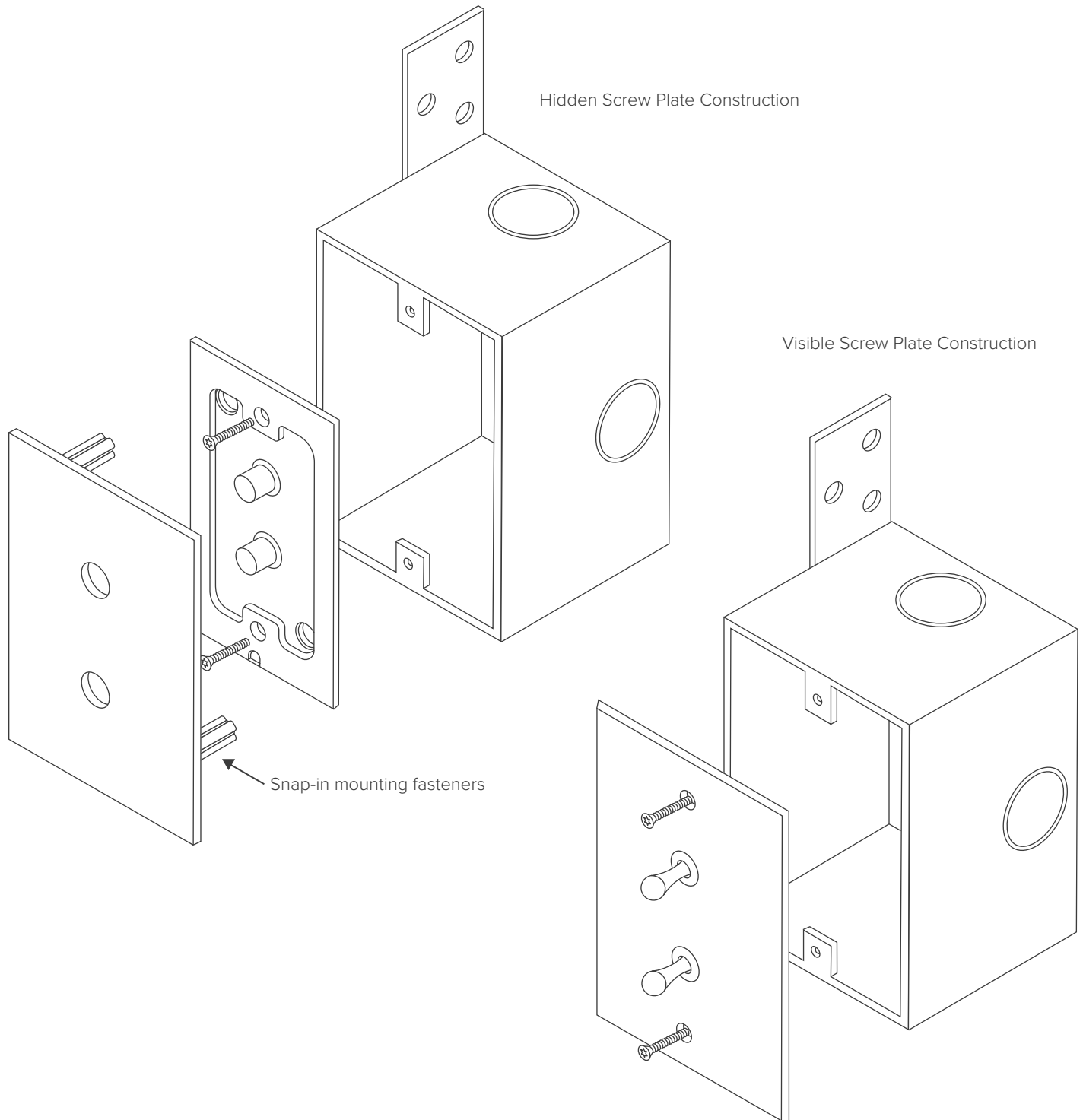



# CLASSIQUE KEYPADS – 117 MM || SPECIFICATION SHEET

**PROJECT NAME:** \_\_\_\_\_

**SPECIFIER:** \_\_\_\_\_

**PLATE FINISH:** \_\_\_\_\_



<p><b>SCREW TYPE</b> <small>Select one</small></p> <p><input type="checkbox"/> Visible - Torx Head</p> <p><input type="checkbox"/> Visible - Slot Head</p> <p><input type="checkbox"/> Hidden</p>	<p><b>PLATE ORIENTATION</b> <small>Select one</small></p> <p><input type="checkbox"/> Vertical</p> <p><input type="checkbox"/> Horizontal</p>	<p><b>EDGE TYPE</b> <small>Select one</small></p> <p><input type="checkbox"/> Beveled</p> <p><input type="checkbox"/> Straight</p>	<p><b>BACK BOX</b> <small>Select one</small></p> <p><input type="checkbox"/> MELUS11782 (metal / new construction)</p> <p><input type="checkbox"/> 3rd Party - Manufacturer + Model Number: _____</p>
---	---	--	---

## MECHANISMS

**MECHANISM (TOGGLE / PUSH BUTTON) FINISHES** Select one

- Chrome - default finish for chrome, copper, gunmetal and nickel plates
- Brass - default finish for brass and bronze plates
- Black Chrome - premium option
- Matched to plate finish - premium option; see [Finish Catalog](#) for available finishes.

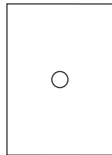
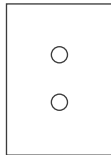
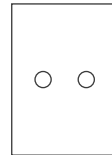
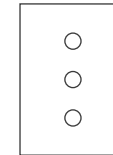
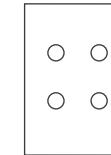
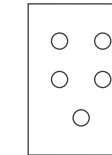
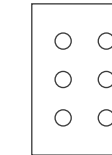
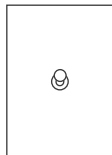
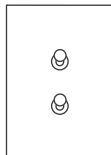
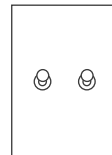
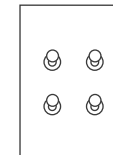
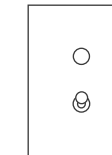
**TOGGLE / PUSH BUTTON CONFIGURATIONS** Select one

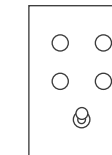
						
<input type="checkbox"/> 1 BP	<input type="checkbox"/> 2 BP (C)	<input type="checkbox"/> 2 BP (R)	<input type="checkbox"/> 3 BP	<input type="checkbox"/> 4 BP	<input type="checkbox"/> 5 BP	<input type="checkbox"/> 6 BP
						
<input type="checkbox"/> 1 INV	<input type="checkbox"/> 2 INV (C)	<input type="checkbox"/> 2 INV (R)	<input type="checkbox"/> 4 INV	<input type="checkbox"/> 1 BP + 1 INV	<input type="checkbox"/> 2 BP + 2 INV	<input type="checkbox"/> 4 BP + 1 INV

Notes:

- 1) Vertical configurations may also be specified with a horizontal plate orientation.
- 2) if an alternate configuration is desired, please contact Meljac North America for confirmation.

## CLASSIQUE KEYPADS – 117 MM || SPECIFICATION SHEET

---

### ENGRAVINGS

**PLACEMENT** Select one

- Above Mechanism
- Below Mechanism
- No Engravings

**STYLE** Select one

- Mechanical
- Resin-filled: RAL Color \_\_\_\_\_
- Screen-Printed
- Back-lit

**FONT** Select one

- Arial
- Helvetica
- Custom \_\_\_\_\_

**SIZE** Select one

- 3 mm
- 3.5 mm
- 4 mm
- Custom \_\_\_\_\_