

PRODUCT INFORMATION AND SPECIFICATION SHEET

SOLARIS KEYPADS – 120 MM



SOLARIS KEYPADS 120 MM || PRODUCT INFORMATION

DESCRIPTION

Solaris collection keypads for use with lighting control / home automation systems. Compatible systems include Crestron, Control4, Lutron HomeWorks, Savant and Vantage. Designed in partnership with Sir Marc Newson.

Made in France.

PERSONALIZED PLATE DETAILS

FINISHES

Cover plates are made-to-order in any of the following finishes:

- Polished Chrome
- Sandblasted Gunmetal
- Light Bronze
- Light Bronze Matte
- Medium Bronze
- Dark Bronze
- Satin Brass
- Golden Brushed Brass
- Polished Brass
- Dark Brushed Silver
- Dark Brushed Copper
- Aged Burnished Copper
- Satin Copper, Antique Copper
- Dark Polished Bronze,
- Belgian Gunmetal
- Antique Brass NA

Examples of all our finishes are available in the [Meljac Finish Catalog](#).

MECHANISM FINISH

- Glossy Black Brass - default
- Matched to plate finish - see [Finish Catalog](#) for available finishes.

MECHANISM OPTIONS

Low-voltage momentary dry contact toggles and push buttons for use in class-2 wiring circuits only.

- BP - Momentary Push Button ("normally-open"). One contact closure.
- INV - Three-position toggle switch, returns to center position. Two contact closures ("UP" and "DOWN").
- INV M - Three position latching toggle switch. Switch can rest up at "UP" contact, center "OFF", or "DOWN" contact. Two maintained contact closures.

Mechanisms can be combined and configured according to project control needs.

Note: Additional low-voltage control options available. Contact MNA for more information.

SCREW TYPE	EDGE TYPE	LED FEEDBACK	ENGRAVINGS
• Hidden	• Straight	<ul style="list-style-type: none"> • 3 mm or 8 mm LED Indicators • Backlit Engravings • 12V or 24V remote power required. 	Default: 3 mm / Arial Font / Mechanical Style 9 characters per line + 2 lines per mechanism See MNA Engraving Options for more details.

BACK BOX

MEL11580

See our [Plate Size & Back Box Guide](#) for more information.

CARE / CLEANING INSTRUCTIONS

Buff clean with a dry microfiber cloth only. No liquids, chemicals or cleaning products should ever be used on any Meljac product.

SOLARIS KEYPADS 120 MM || DIMENSIONAL DRAWINGS

DIMENSIONAL DRAWINGS

Measurements: mm (inches)

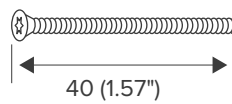
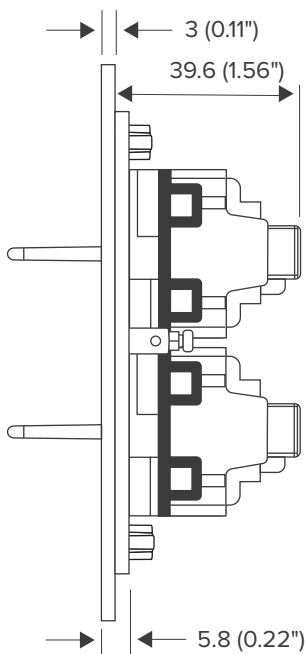
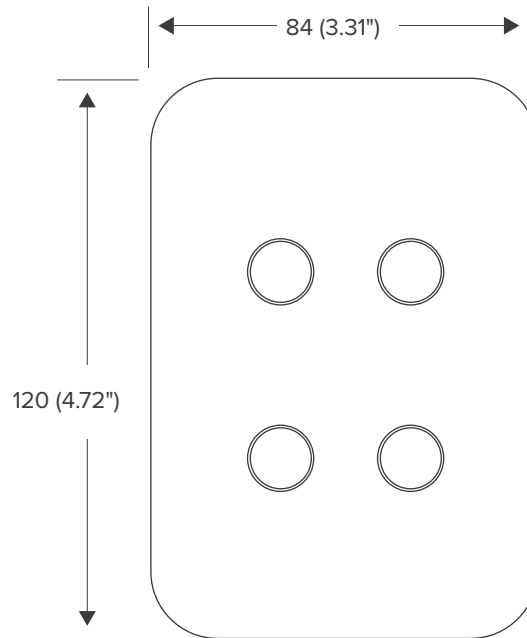
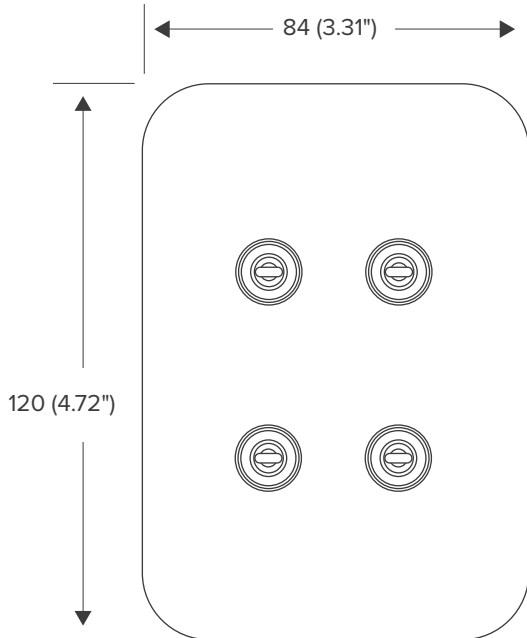

Supplied 6-32
Flat Torx Head
Machine Screw

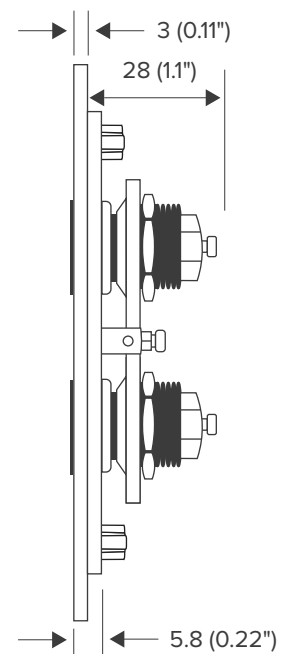

SOLARIS KEYPADS 120 MM || MOUNTING DRAWINGS

BACK BOX

MEL11580

See our [Plate Size & Back Box Reference Guide](#) for more information.

Hidden Screw Plate Construction

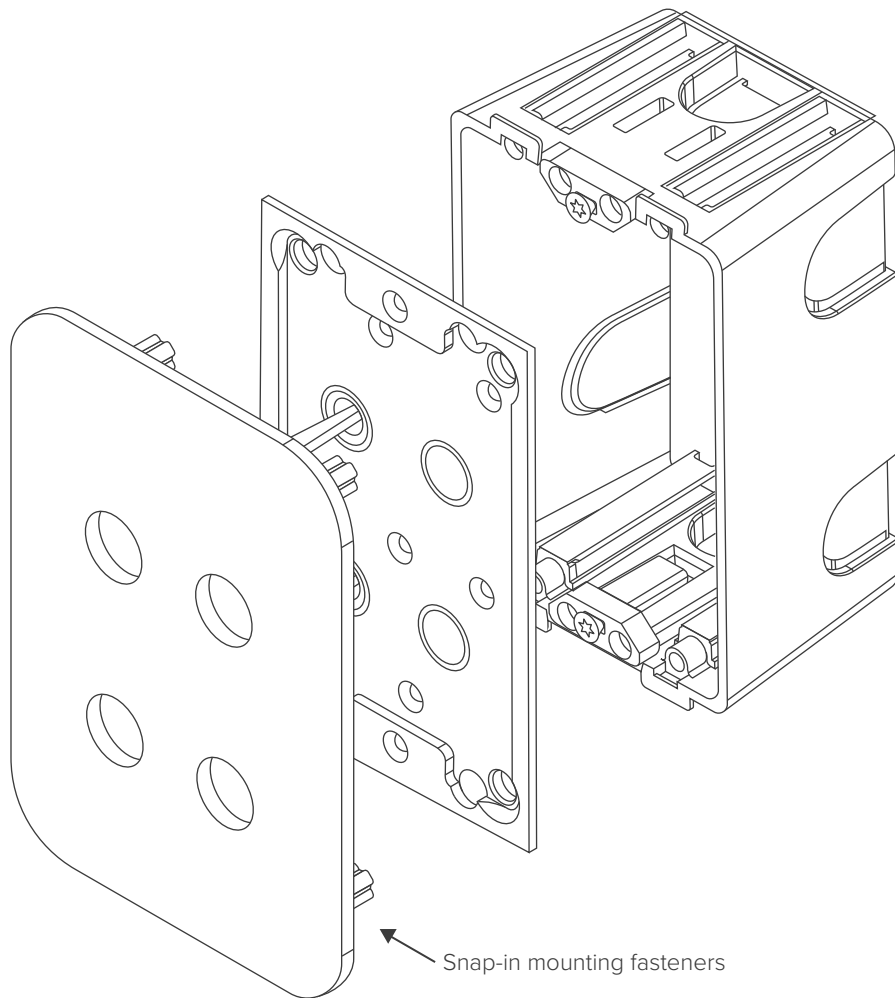

SOLARIS KEYPADS 120 MM || SPECIFICATION SHEET

PROJECT NAME: _____

SPECIFIER: _____

PLATE FINISH: _____

MECHANISM SURROUND FINISH Select one

- Glossy Deep Black - default
- Polished Chrome
- Brushed Brass

TOGGLE / PUSH BUTTON CONFIGURATIONS Select one

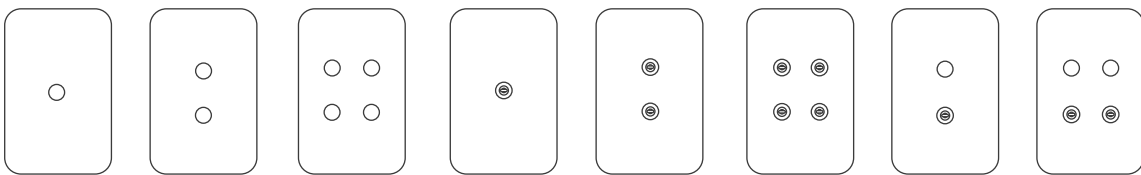

- 1 BP
- 2 BP
- 4 BP
- 1 INV
- 2 INV
- 4 INV
- 1 BP + 1 INV
- 2 BP + 2 INV

ENGRAVINGS

PLACEMENT Select one

- Above Mechanism
- Below Mechanism
- No Engravings

STYLE Select one

- Mechanical
- Resin-filled: RAL Color _____
- Screen-Printed
- Back-lit

FONT Select one

- Arial
- Helvetica
- Custom _____

SIZE Select one

- 3 mm
- 3.5 mm
- 4 mm
- Custom _____